

PRODUCT DATASHEET

Model: LDL811

Category: LED Adjustable Downlight

Description: 24w LED Adjustable Downlight



General Information

Material: Aluminium

Fitting Colors: White/ Black/ Painted Silver

Rotation Angle (degree): 350

Tilting Angle (degree): 30

Track System: Not Applicable

IP Rating: 20

Working Temperature (°C): -5 - +35

Storage Temperature (°C): -20 - +50



Product Dimensions and Cut-out Information

Fitting Length (mm): Not Applicable

Diameter (mm): 172

Height (mm): 204

Cut-out Dimension (mm): 160

Dimension:

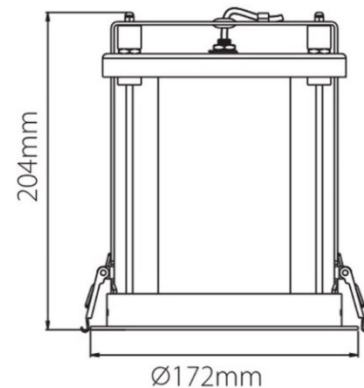

Packing Information

Packaging Type: Individual box

Quantity per carton: 8

CBM per carton: 0.0664

Gross weight per carton (kgs): 15.5

Lifespan

Lifetime (hours): 50000

Luminous Flux after 50000hours (lm): LM80 Comply

PRODUCT DATASHEET

Model: LDL811

Category: LED Adjustable Downlight

Description: 24w LED Adjustable Downlight



Light Technical Information

Color Temperature	CRI (Ra)	Gamut Index (GAI)	System Lumen	Lumen per Watt
2700	90	90	2329	86
2700	95	100	2225	82
3000	90	90	2511	93
3000	95	100	2345	87
3000 Vivid White	90	110	2387	88
4000	95	100	2503	93
5000	80	90	Not Applicable	Not Applicable
5000	90	90	2714	101

LED Manufacturer: Luminus

LED Type: COB

LED Model: CXM-14 Gen 3

Optic: Reflector

Beam Angle (°): 17/24/40/60

Electrical Information

System Power (w): 27

Input Voltage (v) & Frequency: 220-240V 50/60Hz

Output Voltage (v): 31-37

Current (mA): 700